

Spherical roller bearings, cylindrical and tapered bore

Principal dimensions			Basic load ratings		Speed ratings	Limiting speed	Designation
d	D	B	dynamic C	static C0	Reference speed		* SKF Explorer bearing
mm			kN		r/min		-
190	400	132	2232	2650	1200	1600	22338 CCK/W33 *

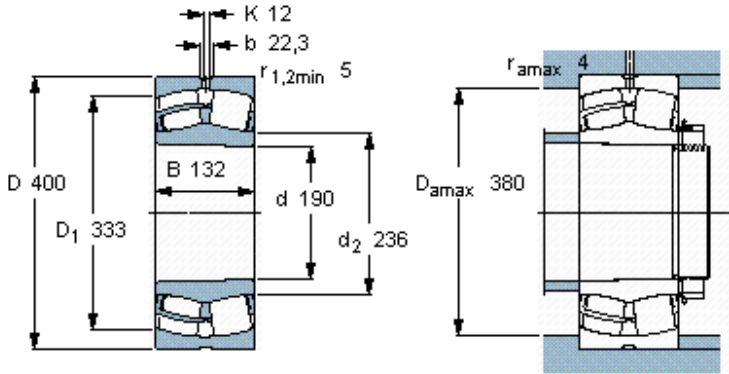

Tapered bore, taper
1: 12

Calculation factors

- e 0,35
- Y_1 1,9
- Y_2 2,9
- Y_0 1,8